

# PRE-ENGINEERED EDGE METAL SOLUTIONS





**Streamlining your projects.  
Satisfying your customers.**



# REDUCING LABOR COSTS & GROWING YOUR PROFITS

Finding the right products that will meet the building requirements, fit within your schedule, and – most importantly – reduce your labor time can make a big difference to your bottom line. This is especially true in the case of roofing, one of the last steps in the construction process, when time is at a premium.

Contrary to your typical shop fabricated metal, Metal-Era's pre-engineered roof edge systems are designed to maximize contractor efficiencies. With a simple installation process, provided fasteners with all major products, and little on-site fabrication required, you can move on to your next project quicker.

Learn more about our roof edge and ventilation systems for your next project by visiting [www.metalera.com](http://www.metalera.com) or call one of our roofing specialists at 800-558-2162.



**FASCIA | COPING | WOOD NAILER ALTERNATIVES |  
WATER CONTROL | ACCESSORIES**

We help you stay on schedule with multiple manufacturing facilities, on-hand standard inventory to get your product in your hands sooner, and a nationwide support network. And it all comes with the confidence of being backed by the best wind and performance warranties in the industry.

With Metal-Era, you keep your project moving, your customers happy and your bottom line strong.

## THE INDUSTRY'S LARGEST PORTFOLIO OF TESTED ROOFING & BUILDING ENVELOPE SOLUTIONS.

**Designed to Provide Simple  
Installation & Labor Savings**

**Multiple Manufacturing Facilities &  
Onsite Inventory**

**Quick-to-Ship Options Available**

**Backed by the Strongest  
Warranties in the Industry**

**ANSI/SPRI/FM 4435/ES-1,  
ANSI/SPRI GT-1, FM Approvals,  
& Miami-Dade County Approved**

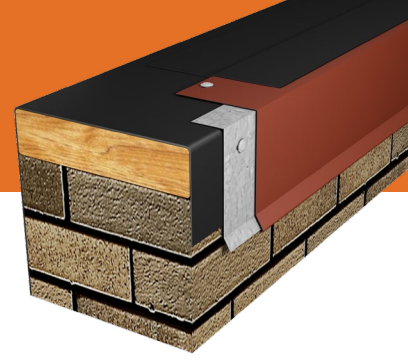

# Edge Systems **ONE** ECONOMICAL | FAST | TESTED

## Great Quality at a Price That Fits Your Budget

Developed with the contractor in mind, Edge Systems One® fascia products combine highly engineered and tested products with quick-to-ship convenience and economical pricing.

Our fast lead times and easy installation translate directly into decreased labor costs and enables you and your team move on to other projects more quickly. As a result, you simplify your projects – and maximize your profits.

## ONE EDGE FASCIA ADVANTAGES

- Includes Metal-Era wind warranty
- Simple, snap-on cover; no crimping needed (One Edge CF, One Edge, One Edge Extended Only)
- Eliminates stripping-in or heat welding (One Edge CF, One Edge, One Edge Extended Only)
- Manufactured in 12' lengths with pre-punched holes to reduce installation time
- Multiple colors, materials, and sizes available
- Includes all fasteners to ensure proper install and lower material costs

PRODUCT LINE						
	<b>ONE EDGE CF</b>	<b>ONE EDGE</b>	<b>ONE EDGE EXTENDED</b>	<b>ONE DRIP EDGE</b>	<b>ONE DRIP EDGE</b>	<b>ONE GRAVEL STOP</b>
VERSIONS	• Single-Ply	• Single-Ply • Built-up or Modified	• Single-Ply • Built-up or Modified	• Kynar® • Flash-Thru	• TPO Coated • PVC Coated • TPO Coated (Skirted) • PVC Coated (Skirted)	• Kynar®
COVER MATERIALS	24 ga., 22 ga. .040", .050"	24 ga., 22 ga. .040", .050", .063"	22 ga. .050", .063"	24 ga., 22 ga. .040", .050", .063"	24 ga. with TPO or PVC Coating (with or without Factory-Applied Flashing)	24 ga., 22 ga. .040", .050", .063"
WIND WARRANTY	20-Year, 120 MPH	20-Year, 120 MPH	20-Year, 120 MPH	10-Year, 90 MPH	10-Year, 90 MPH	10-Year, 90 MPH
ANSI/SPRI/FM 4435/ES-1 TESTED	X	X*	X	X	X	X
FM APPROVED	X	X*	X	X	X	X
MIAMI-DADE COUNTY APPROVED	X	X*	X	X	X	X

\* Testing in 24 ga. , 22 ga. & .040" Only

# 5-STEP EASY INSTALLATION

## One Edge Fascia Single-Ply

**STEP 1** ●

Place membrane over roof edge, fully covering nailer.

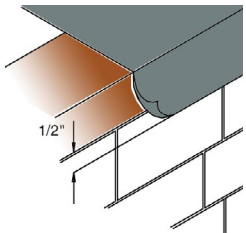

**STEP 2** ● ●

Apply sealant to rail (shown with inside face up).

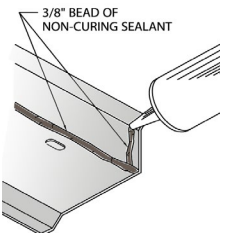

**STEP 3** ● ● ●

Fasten base rail to nailer through provided slots.

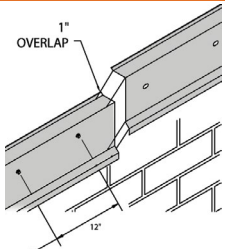

**STEP 4** ● ● ● ●

Place spring clips every 4 feet on-center (typical).

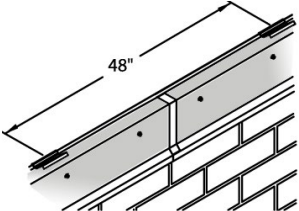

**STEP 5** ● ● ● ● ●

Remove protective film from cover; snap onto base rail.

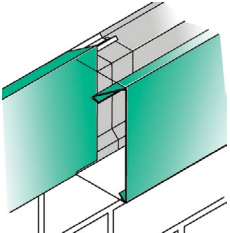



# Anchor-Tite





## The Best Protection Available for Your Roof Edge

Anchor-Tite® fascia products combine custom engineering and superior performance with an attractive appearance.

The patented design of our extruded aluminum anchor bar securely terminates the membrane — providing protection superior to any other shop-fabricated roof edge.

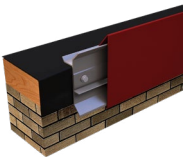
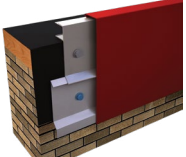
## ANCHOR-TITE ADVANTAGES

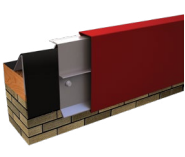
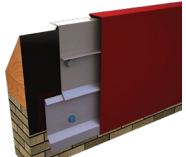
- Lifetime, 215 MPH Wind Warranty
- Simple, snap-on design cover with need to strip-in or heat weld
- Prefabricated miters and accessories ensure proper fit and eliminate field fabrication
- Manufactured in 12' lengths with pre-punched holes to reduce installation time

PRODUCT LINE						
	STANDARD	EXTENDED	HG	CANTED	CANTED EXTENDED	DRIP EDGE
VERSIONS	<ul style="list-style-type: none"> <li>• Single-Ply</li> <li>• Single-Ply With Butyl Strip</li> <li>• Built-up or Modified</li> </ul>	<ul style="list-style-type: none"> <li>• Single-Ply</li> <li>• Built-up or Modified</li> </ul>	<ul style="list-style-type: none"> <li>• Single-Ply</li> <li>• Single-Ply With Butyl Strip</li> <li>• Built-up or Modified</li> </ul>	<ul style="list-style-type: none"> <li>• Galvanized Waterdam</li> <li>• Existing Beveled Wood Nailer</li> </ul>	<ul style="list-style-type: none"> <li>• Galvanized Waterdam</li> <li>• Existing Beveled Wood Nailer</li> </ul>	<ul style="list-style-type: none"> <li>• Standard</li> <li>• Pitched</li> </ul>
COVER MATERIALS	24 ga., 22 ga. .040"	22 ga. .050", .063"	24 ga., 22 ga. .040", .050", .063"	24 ga., 22 ga. .040", .050", .063"	22 ga. .050", .063"	24 ga., 22 ga. .040"
ANSI/SPRI/FM 4435/ES-1 TESTED	X	X	X	X*	X*	X
FM APPROVED	X	X	X	X*	X*	X
MIAMI-DADE COUNTY APPROVED	X	X	X	X*	X*	X

\*Testing on Galvanized Waterdam Version Only

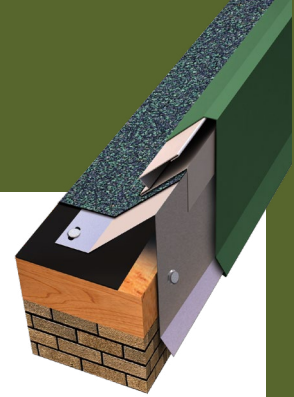

# Perma-Tite

Versatile, Economical Products in a Range of Designs, Colors, & Finishes

Perma-Tite® features a distinct design and competitive pricing that makes this line of fascia products the perfect solution for multiple roof conditions. With no exposed fasteners or unsightly cover plates, the clean design prevents migration under the fascia panels and provides proper spacing for thermal movement.

## PERMA-TITE FASCIA ADVANTAGES

- 20-Year, 120 MPH Wind Warranty
- Manufactured in 12' lengths to reduce material handling and installation time
- Dual attachment points for added flexibility for roof irregularities
- All fasteners included

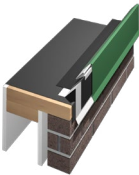
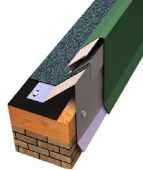
PRODUCT LINE	 <b>SYSTEM 200</b>	 <b>SYSTEM 300</b>
VERSIONS	<ul style="list-style-type: none"> <li>• Single-Ply, Snap-on</li> <li>• Single-Ply, Crimp-on</li> </ul>	Built-up or Modified
COVER MATERIALS	24 ga., 22 ga. .040", .050", .063"	24 ga. 22 ga. .040", .050", .063"
ANSI/SPRI/FM 4435/ES-1 TESTED	<b>X</b>	<b>X</b>
FM APPROVED	<b>X</b>	<b>X</b>
MIAMI-DADE COUNTY APPROVED	<b>X</b>	<b>X</b>



Custom Roof Edges That Inspire

## CDS FASCIA ADVANTAGES

- 20-Year, 120 MPH Wind Warranty
- Versions: Bullnose, Cornice, Shadow Line (Available in Single-Ply and Built-up or Modified)
- Looks great without complicated installation or stripping-in or heat welding

Our Creative Design Series fascia products allow you to choose from unique designs that are perfect for a variety of commercial buildings. These fascia products deliver superior performance and are available in a variety of designs, colors, and materials.

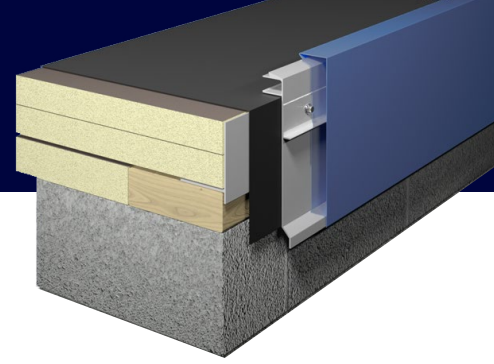



# ELIMINAILER-T & EDGEBOX RI

Metal-Era's wood nailer alternative products make using a wood nailer obsolete. The roof perimeter and corners serve as the first line of defense against severe winds, rain, hail, storms, tornados, hurricanes, and much more. If the edge fails, the entire roof system is in jeopardy.

Replacing old wood nailers at the building perimeter with Eliminailer-T or EdgeBox RI significantly reduces the risk of failure and helps protect the entire roof system from costly damages and blow off.

## WOOD NAILER ALTERNATIVE ADVANTAGES

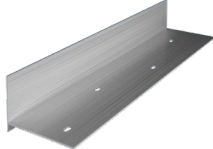
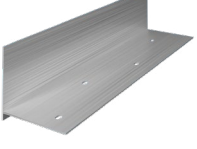
- Lifetime, 215 MPH Wind Warranty
- Made with heavy gauge materials that will not warp, crack, split, rot, or deform
- Easy, precise installation with pre-punched holes and fasteners, installing faster than wood nailer
- Continuous insulation to the roof edge
- Used for a variety of applications including simplifying metal roof retrofit projects

PRODUCT LINE	 ELIMINAILER-T	 ELIMINAILER-T FOR METAL RETROFITS	 EDGEBOX RI
VERSIONS	<ul style="list-style-type: none"> <li>• 1.5" x 2.5"</li> <li>• 1.5" x 5.5"</li> <li>• 3" x 2.5"</li> <li>• 3" x 5.5"</li> <li>• 5.2" x 4"</li> <li>• 5.2" x 5.5"</li> </ul>	<ul style="list-style-type: none"> <li>• 1.5" x 5.5"</li> <li>• 3" x 5.5"</li> </ul> (Pitched or Non-Pitched)	<ul style="list-style-type: none"> <li>• 3.5" Min/16" Max (Width)</li> <li>• 1.25" Min/16" Max (Height)</li> </ul>
MATERIALS	Heavy Gauge Aluminum	Heavy Gauge Aluminum	20 ga. Galv. Steel (Spines required when over 6")
ANSI/SPRI/FM 4435/ES-1 TESTED	X	X	X*
FM APPROVED	X	X	X*
MIAMI-DADE COUNTY APPROVED	X	X	X*

\* Tested up to 4.5" (Height) & 5.5" (Width)

## ELIMINAILER-T FOR FLUTE-FILLED FEAT. ANCHOR-TITE DRIP EDGE

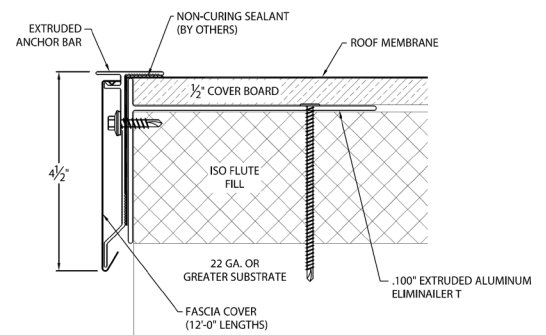



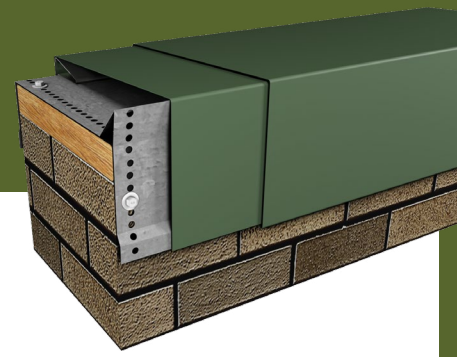

# Perma-Tite

## Proven Protection & a Perfect Fit

Continuing a tradition of innovative, rigorously tested roof edge systems, Perma-Tite coping products are a fine complement to your building's natural aesthetics. A variety of options, including standard and custom colors as well as anodized finishes, accommodate multiple roof conditions. It's exactly what you need for your building: the right design, the right quality, the right price – and easy to install.

## PERMA-TITE COPING ADVANTAGES

- Includes Metal-Era wind warranty
- Reduces labor time and costs with simple, snap-on installation
- Prefabricated miters, fasteners, and accessories ensure proper fit and eliminates field fabrication
- Facilitates correct placement and proper thermal movement with slotted fastening holes

PRODUCT LINE					
	<b>PERMA-TITE GOLD</b>	<b>PERMA-TITE</b>	<b>PERMA-TITE CANTILEVER</b>	<b>PERMA-TITE DOUBLE TAPERED</b>	<b>PERMA-TITE CONTINUOUS CLEAT</b>
VERSIONS	<ul style="list-style-type: none"> <li>• Tapered</li> <li>• Flat</li> <li>• Existing Slope</li> </ul>	<ul style="list-style-type: none"> <li>• Tapered</li> <li>• Flat</li> <li>• Existing Slope</li> </ul>	<ul style="list-style-type: none"> <li>• Single</li> <li>• Double</li> </ul>	<ul style="list-style-type: none"> <li>• Tapered</li> <li>• Existing Slope</li> </ul>	<ul style="list-style-type: none"> <li>• Tapered</li> <li>• Flat</li> <li>• Existing Slope</li> </ul>
WIND WARRANTY	Lifetime, 215 MPH	20-Year, 120 MPH	20-Year, 120 MPH	20-Year, 120 MPH	20-Year, 120 MPH
COVER MATERIALS	24 ga., 22 ga. .040", .050", .063"	24 ga., 22 ga. .040", .050", .063"	24 ga., 22 ga. .040", .050", .063"	24 ga., 22 ga. .040", .050", .063"	24 ga., 22 ga. .040", .050", .063"
DESIGN ELEMENTS	16 ga. Clip Flush Face Snap-on	20 ga. Clip Drip Profile Snap-on	16 ga. Clip/ 20 ga. Riser Flush Face Snap-on	20 ga. Clip Drip Profile Snap-on	20 ga. Cleat (Inside & Outside) Crimp-on
TESTED MAX WALL WIDTH	24" (.040"/24 ga.) 32" (.050"/.063"/22 ga.)	16"	24"*	N/A	24"
ANSI/SPRI/FM 4435/ES-1 TESTED	X	X	X*		X
FM APPROVED	X	X	X*		X
MIAMI-DADE COUNTY APPROVED	X	X	X*		X

\* Single Cantilever Version Only



## Edge Systems **ONE** ECONOMICAL | FAST | TESTED

### Coping with Your Budget, Schedule, & Time in Mind

Developed with contractors in mind, Edge Systems One is a great alternative to shop-fabricated coping - economically priced, yet made to exacting standards. Our fast lead times and easy installation translate directly into decreased labor costs and enable you and your team to move on to other projects more quickly.



### ONE EDGE COPING ADVANTAGES

- 10-Year, 90 MPH Wind Warranty
- Versions: Tapered, Flat, Existing Slope
- ANSI/SPRI/FM 4435/ES-1 Tested
- Cover Materials: 24 ga., 22 ga. Steel and .040", .050", .063" Aluminum
- 12 ft. lengths and all fasteners included for easy installation

## Creative Design *Series*

### Design-Friendly Options to Match Your Building

Creative Design Series is perfect for any commercial building. With its unique designs, it is sure to complement any high-profile building projects.

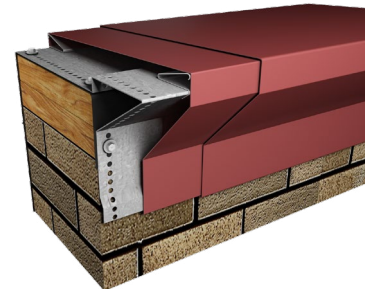

### CDS COPING ADVANTAGES

- 20-Year, 120 MPH Wind Warranty
- Versions: Bold Face, Bullnose, Cornice, Leak-Tite, Reveal, Stone-Look
- Looks great without complicated installation
- Prefabricated miters and accessories ensure proper fit and eliminate field fabrication
- Reveal Coping: ANSI/SPRI/FM 4435/ES-1 Tested (Up to 16" Wall width)

# Seal-Tite

## Superior Water Drainage in Any Weather Conditions

Unique design, superior roof drainage, and attractive appearance make Seal-Tite gutters and downspouts stand out from the crowd. Seal-Tite WR and XL Gutters are specifically engineered and tested to meet the requirements of the ANSI/SPRI GT-1 Standard for Gutter Systems Used with Low-Slope Roofs. The design incorporates heavy-gauge aluminum internal gutter brackets for strength and support to ensure the system stays secured to prevent wind uplift—no external brackets or wind straps needed.

## SEAL-TITE GUTTER ADVANTAGES

- Includes manufacturer’s wind warranty
- ANSI/SPRI/GT-1 tested to comply with International Building Code (WR & XL Gutters)
- Slotted fastening holes to ensure correct fastener placement and spacing
- Prefabricated miters, fasteners, and accessories ensure proper fit and eliminates field fabrication

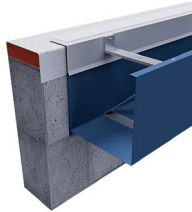
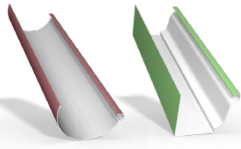
PRODUCT LINE	 WR GUTTERS	 XL GUTTERS	 LT GUTTERS	 INDUSTRIAL DOWNSPOUTS	 LT DOWNSPOUTS
VERSIONS	<ul style="list-style-type: none"> <li>• Offset</li> <li>• Chamfer</li> <li>• Box</li> </ul>	<ul style="list-style-type: none"> <li>• Box</li> </ul>	<ul style="list-style-type: none"> <li>• Half Round</li> <li>• K-Style</li> </ul>	<ul style="list-style-type: none"> <li>• Closed</li> <li>• Open Face</li> </ul>	<ul style="list-style-type: none"> <li>• Round</li> <li>• Corrugated</li> </ul>
SIZES	<p><b>Bottom Width &amp; Front Height:</b> 5.25", 5.75", 6.25", 6.75", 7.25", 7.75"</p> <p><b>Back Height:</b> 1" More Than Front Height</p>	<p><b>Bottom Width &amp; Front Height:</b> 8", 9", 10", 11", 12", 13", 14"</p> <p><b>Back Height:</b> 1" More Than Front Height</p>	<p><b>Half Round:</b> 5", 6", 7", 8", 9", 10" (Diameter)</p> <p><b>K-Style:</b> 6", 7", 8" (Width)</p>	<p><b>Width:</b> Min. 3"   Max. 10"</p> <p><b>Depth:</b> Min. 3"   Max. 10"</p>	<p><b>Round:</b> 3", 4", 5", 6", 8" (Diameter)</p> <p><b>Corrugated:</b> 3" x 4" &amp; 4" x 5"</p>
MATERIALS	24 ga., 22 ga. .040", .050", .063"	22 ga. .050", .063"	24 ga., 22 ga. .032", .040", .050"	24 ga., 22 ga. .040", .050", .063"	24 ga., 22 ga. .032", .040", .050"
WARRANTY	30-Year, 160 MPH	30-Year, 160 MPH	10-Year, 90 MPH	5-Year Workmanship	5-Year Workmanship
ANSI/SPRI GT-1 TESTED	X	X		N/A	N/A
FM APPROVED	X	X		N/A	N/A
MIAMI-DADE APPROVED	X			N/A	N/A

See accessories for information on other water drainage solutions.





# Accessories

## High-Quality Products to Complete Your Roofing Projects

Designed to provide long-lasting performance, Metal-Era’s accessories supply the flexibility to fit any project. Easy to install, our accessories are effective as a complement to our other product lines or as a stand-alone application. Each product comes with a 5-year workmanship warranty and offers the performance and consistency you and your customers rely on.

<b>PRODUCT LINE</b>	 <p><b>EXPANSION JOINTS</b></p>	 <p><b>COUNTERFLASHING</b></p>	 <p><b>TERMINATION BAR</b></p>
<b>VERSIONS</b>	<ul style="list-style-type: none"> <li>• Roof to Wall</li> <li>• Roof to Roof</li> <li>• Roof to Wall (3-Axis)</li> <li>• Roof to Roof (3-Axis)</li> </ul>	<ul style="list-style-type: none"> <li><b>1 piece</b> <ul style="list-style-type: none"> <li>• Reglet</li> </ul> </li> <li>• Surface Mounted</li> <li><b>2 pieces</b> <ul style="list-style-type: none"> <li>• Reglet</li> </ul> </li> <li>• Surface Mounted</li> <li>• Thru Wall</li> </ul>	<ul style="list-style-type: none"> <li>• Termination Bar Fascia <ul style="list-style-type: none"> <li>• Extruded</li> <li>• Formed</li> <li>• Paver</li> </ul> </li> </ul>
<b>PRODUCT LINE</b>	 <p><b>DRAIN BAR</b></p>	 <p><b>WATER DRAINAGE</b></p>	 <p><b>OTHER</b></p>
<b>VERSIONS</b>	<ul style="list-style-type: none"> <li>• Flow-Thru</li> <li>• Garden-Tite</li> </ul>	<ul style="list-style-type: none"> <li>• Thru-Wall Scupper <ul style="list-style-type: none"> <li>• Collector Boxes</li> </ul> </li> <li>• Thru-Wall Scuppers w/ Collector Box</li> <li>• Garden-Tite Inspection Chamber</li> </ul>	<ul style="list-style-type: none"> <li>• Brick Wall Cap (shown) <ul style="list-style-type: none"> <li>• Soffit Cleat</li> </ul> </li> <li>• Lightning Rod Brackets <ul style="list-style-type: none"> <li>• Extender</li> </ul> </li> <li>• Extender with Offset</li> </ul>

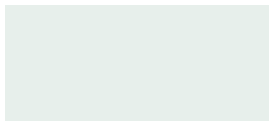
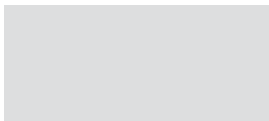

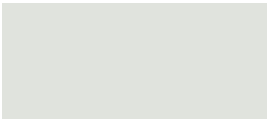



## Express Colors\*

				
Almond	Bone White	Cityscape	Clear Anodized	Dark Bronze
				
Medium Bronze	Sandstone	Sierra Tan	Slate Gray	Stone White

## Standard Colors

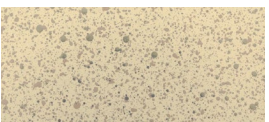
				
Aged Bronze	Antique Bronze	Black ▲	Buckskin	Cardinal (Regal) Red
				
Charcoal (Charcoal Gray)	Classic Bronze	Colonial Red	Evergreen	Forest (Sherwood) Green
				
Granite	Hartford Green	Hemlock Green	Inkwell	Interstate (Regal) Blue
				
Iron Ore	Mansard Brown	Midnight (Extra Dark) Bronze	Musket Gray	Onyx (Matte Black) ▲
				
Pacific Blue	Patina Green ▲	Regal White	Sky (Military) Blue	Terra Cotta

## Premium Colors

				
Award Blue	Champagne (Metallic)	(Classic) Copper Penny	Sand Stone ■ ★	Silver (Metallic)
				
Silversmith	Weathered Zinc	Zinc		

\* = Also in Mill Finish  
 ■ = Post-Painted  
 ▲ = Must Specify Supplier  
 ★ = Available in 3 Other Stone Colors

Our colors are deep, rich and true. Made of Valspar's Fluropon® High Performance Hylar 5000®/Kynar 500® finish, they offer the ultimate in resistance against fading and weathering. Custom colors also available.



# THE INDUSTRY'S BEST WARRANTIES

Because every Metal-Era product is carefully designed, fabricated, and tested, we stand by our quality with industry leading wind and performance warranties. Metal-Era warranties are for replacement or repair of any portion of the system that has failed due to a defect in Metal-Era supplied materials. Covers the roof edge for the number of years listed on the roof on which it was originally installed.

PRODUCT LINE	WARRANTY				
	LIFETIME 215 MPH WIND	30-YEAR 160 MPH WIND	20-YEAR 120 MPH WIND	10-YEAR 90 MPH WIND	5-YEAR WORKMANSHIP
ACCESSORIES					X
ANCHOR-TITE (FASCIA & DRIP EDGE)	X				X
CREATIVE DESIGN SERIES (COPING & FASCIA)			X		X
EDGE SYSTEMS ONE (FASCIA)			X		X
EDGE SYSTEMS ONE (COPING, DRIP EDGE, GRAVEL STOP)				X	X
ELIMINAILER-T & EDGEBOX RI (WOOD NAILER ALTERNATIVE)	X				X
PERMA-TITE GOLD (COPING)	X				X
PERMA-TITE (COPING & FASCIA)			X		X
SEAL-TITE WR & XL (GUTTERS)		X			X
SEAL-TITE LT (GUTTERS)				X	X

All products listed above include a Kynar® Paint Warranty. Custom post-coated Kynar 500® colors are available with an included 10-year Kynar 500® finish warranty or a 20-year Kynar 500® finish warranty is available upon request.





# REGIONAL TECHNICAL SALES

## Complimentary Field Measurement, Takeoffs, & Training for Contractors

Metal-Era's Regional Technical Sales is a nationwide team available to customers for complimentary field measurements, job ordering, and training for contractors.

- Save time and money when our experts measure and order your jobs, reducing/eliminating errors
- Field measurement details provided by RTS protects the installing contractor from mismeasurement
- Ensure proper coverage of challenging components
- Expert technical advice on-site at no charge
- Products comply with ANSI/SPRI/FM 4435/ES-1, ANSI/SPRI GT-1, FM, Miami Dade, and Florida Building Code for IBC compliance

## THE FALCON ROOF MEASUREMENT TOOL

### New Technology Revolutionizes Approaching the Roof Edge



Available through our nationwide RTS team, The Falcon Roof Measurement Tool expedites the entire process of measuring the roof perimeter, including quoting, delivery, and installation.

- Creates an illustrated roadmap to improve speed, efficiency, and accuracy of installation
- Precision within thousandths of an inch and tenths of a degree
- Hybrid clamping device accurately measures all parapet surfaces
- Radius, miters, transitions, end walls, and other unique and difficult details are simple to measure
- Labor savings increases capacity and gets you off the roof faster

**VISIT [METALERA.COM/RTS](https://www.metalera.com/RTS)  
TO SCHEDULE A VISIT TODAY!**

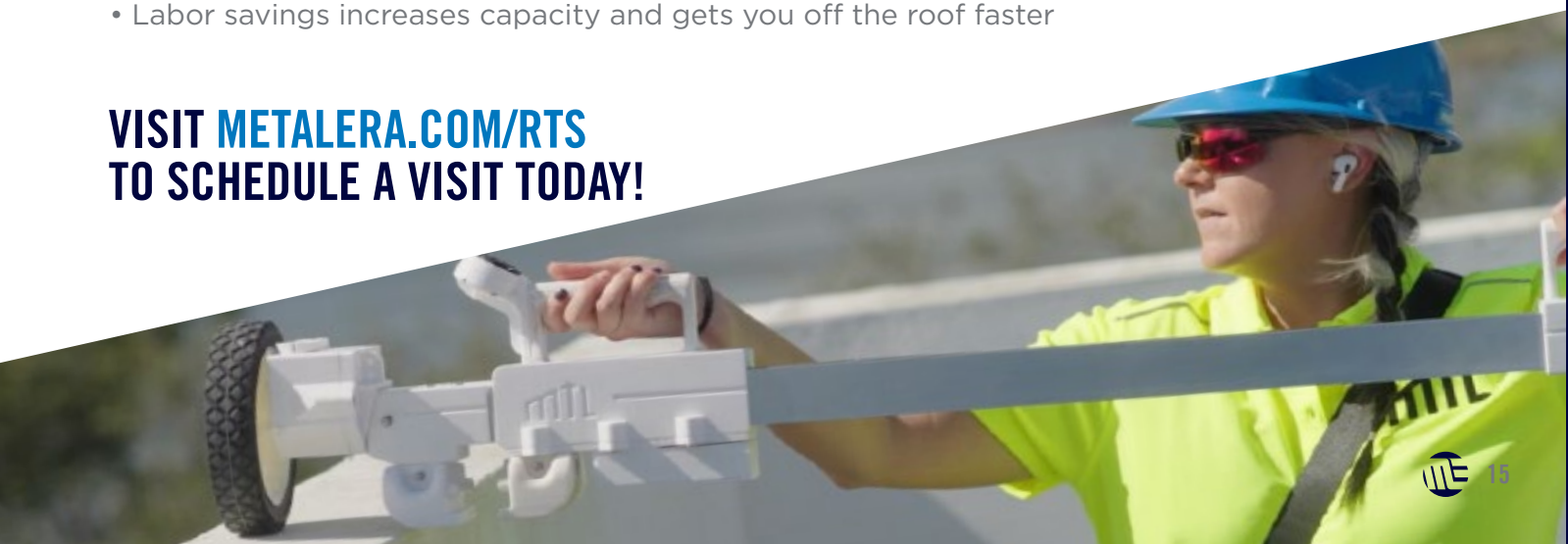



Metal-Era  
1600 Airport Road  
Waukesha, WI 53188

[www.metalera.com](http://www.metalera.com)  
[info@metalera.com](mailto:info@metalera.com)  
800-558-2162

