

WOOD NAILER ALTERNATIVES

ELIMINAILER-T & EDGEBOX RI





PROTECTING THE BUILDING ENVELOPE

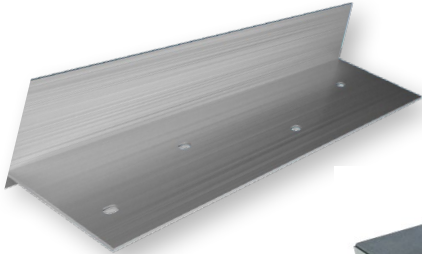

Eliminailer-T



EdgeBox RI

Wood Nailer Alternative Benefits:

- Strengthens and protects the roof perimeter
- Reduces the risk of roof system failures
- Creates a consistent, secure edge for roof assembly attachment



What if you didn't need a wood nailer?

Metal-Era makes using a wood nailer obsolete. The roof perimeter and corners serve as the first line of defense against severe winds, rain, hail, storms, tornados, hurricanes, and much more. If the edge fails, the entire roof system is in jeopardy.

Replacing old wood nailers at the building perimeter with Eliminailer-T or EdgeBox RI significantly reduces the risk of failure and helps protect the entire roof system from costly damages and blow off.

WOOD NAILER ALTERNATIVES AT-A-GLANCE

215 MPH Lifetime Wind Warranty

Superior Roof Edge Securement

Lasting Building Perimeter Protection

Enhanced Thermal Performance

Faster Install, Less Labor

Sustainable & Non-Combustible

PRIMARY APPLICATIONS

**Standard Low Slope
Consistent Perimeter Height
Non-Tapered**

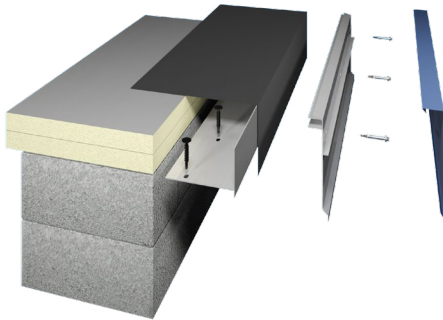

**Standard Low Slope With
Parapet Wall**

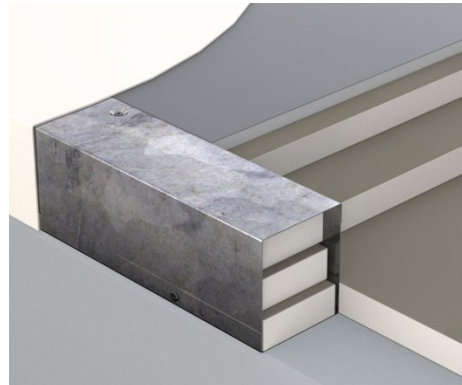

**Metal Roof Retrofit
Up to a 4/12 Pitch**

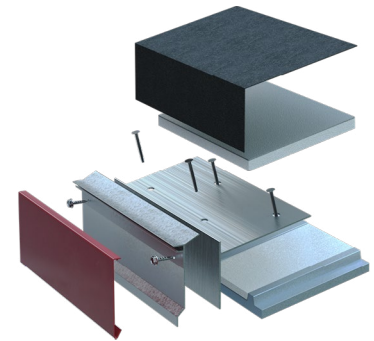

ALTERNATIVES VERSUS WOOD NAILERS

WOOD NAILER ALTERNATIVE BENEFITS	WOOD NAILER COMPARISON
Warranty and performance protection with wind coverage up to a Category 5 Hurricane	No warranty or performance guarantee
FM Tested up to 1-990 (Eliminailer-T) and 1-540* (EdgeBox RI) at the perimeter rating.	Not as structurally strong as heavy gauge extruded aluminum
Heavy gauge materials that will not warp, crack, split, rot, or deform	Wood deteriorates from moisture, mold, insects, and more
Continuous insulation to the roof edge (up to a 47% increase in R-value at the edge with Eliminailer-T)	Prevents insulation from reaching the roof edge, allowing energy to escape and moisture to get in
Easy and precise installation with pre-punched holes, installing up to 60% faster than wood nailers	Wood can be uneven, requiring additional prep time before and during installation
Non-combustible, made with recycled materials	Combustible and serves as a food source for insects and mold

* Max 4.5" Height and 5.5" Width



SIMPLIFY METAL ROOF RETROFITS

Imagine drastically reducing the time and labor it would take to retrofit a metal roof flute fill project. That dream can become a reality if designed with Eliminaailer-T, which makes flute fill installations fast and easy by eliminating wood blocking assemblies.

With Eliminaailer-T, installers no longer have to cut individual wood blocks to fit each pan section. In addition, it is possible to extend insulation to the roof edge, improving thermal performance.

Eliminaailer-T fits securely against the roof perimeter and is designed for quick fastening into the purlins or structural supports using pre-punched holes. Add a 1/2" cover board on top to finish.

Eliminaailer-T provides superior edge securement and is backed by Metal-Era's 215 MPH Lifetime Wind Warranty. Wood nailers take significantly more time to install and offer no warranty protection or performance guarantee.

Designing metal roof retrofits to include Eliminaailer-T has numerous benefits including:

- Simple, easy installation (up to 60% faster)
- Elimination of wood blocking assemblies
- Superior and lasting edge securement
- Unmatched 215 MPH lifetime wind warranty



ELIMINAAILER-T IS DESIGNED TO MAKE METAL RETROFIT INSTALLATION EASY, SAVING TIME AND LABOR WHILE REDUCING HASSLE FOR INSTALLERS.

METAL ROOF RETROFIT APPLICATIONS

Eliminailer-T offers versatility on metal retrofit projects. The nailer alternative comes in a variety of sizes (1.5" x 2.5" and 3" x 5.5" up to a 4/12 pitch) with the option to accommodate additional layers of insulation on top.

Pitched Flute Fill Application: Coverboard

Pitched Flute Fill Application: Extra Insulation

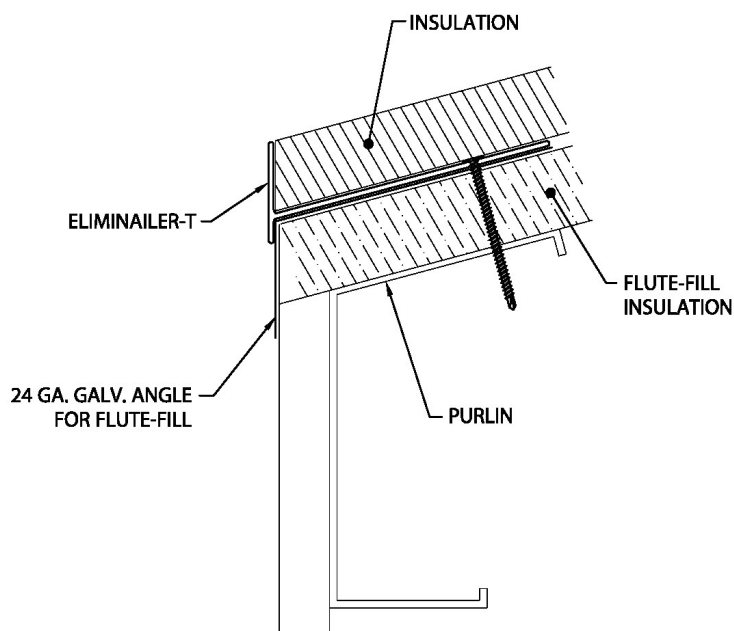
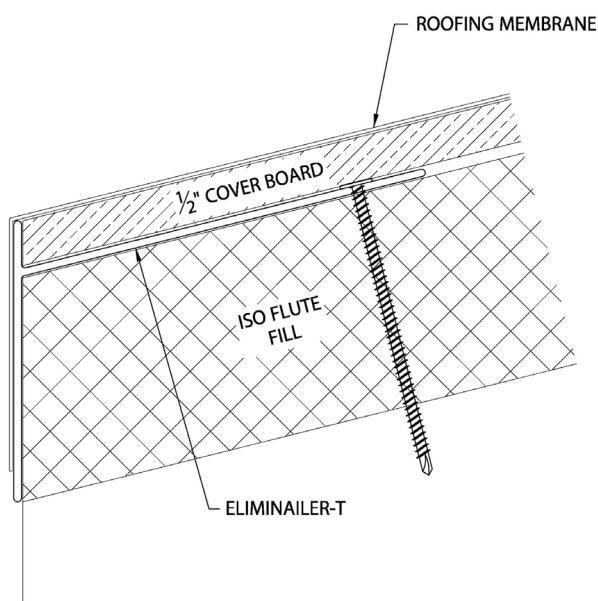

Companion Products for Metal Roof Retrofits

Eave: Drip Edge or Gutter

Rake: Fascia

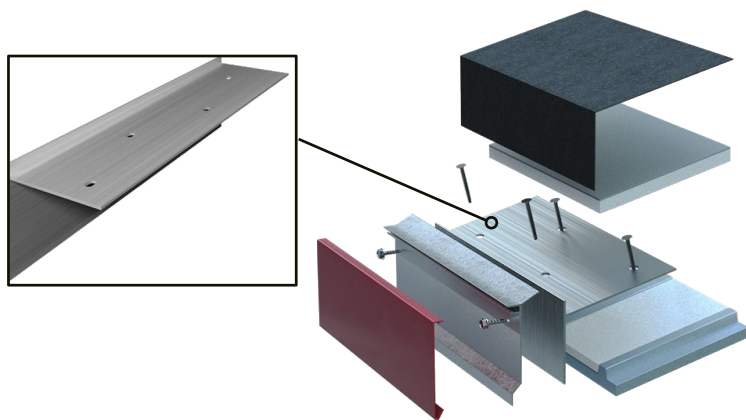

Eliminailer-T shown on flute-filled application featuring Anchor-Tite Drip Edge.





STRONG PERIMETERS ON LOW SLOPE ROOFS

Constructing a roof edge that meets design needs, building code for wind uplift, and delivers lasting performance is critical to reducing risk of failure and safeguarding the building and its contents.

Wood nailers deteriorate and create weaknesses along the building perimeter and corners, leaving the roof system vulnerable to a failure. Eliminaailer-T and Edgbox RI help solve common challenges with wood nailers to provide a superior, long-term solution.

On low slope applications where the perimeter roof height is consistent and is not tapered, Eliminaailer-T and EdgeBox RI is a great alternative to wood nailers for both new construction and re-roof projects. They can be used on an existing wood nailer, if secure, or in place of wood nailers to achieve desired R-value.

5.2" Eliminaailer-T Thermal Performance

Eliminaailer-T protects the roof assembly, significantly reducing the chance for energy loss and condensation. Initial testing shows up to a 47% improvement in R-value at the edge.

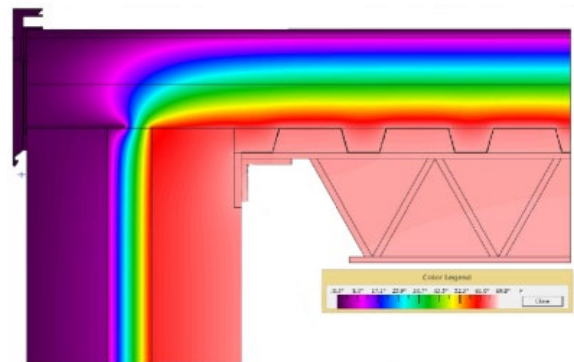



Source: Intertek, Oct 2017

Eliminaailer-T with Anchor-Tite HG Fascia

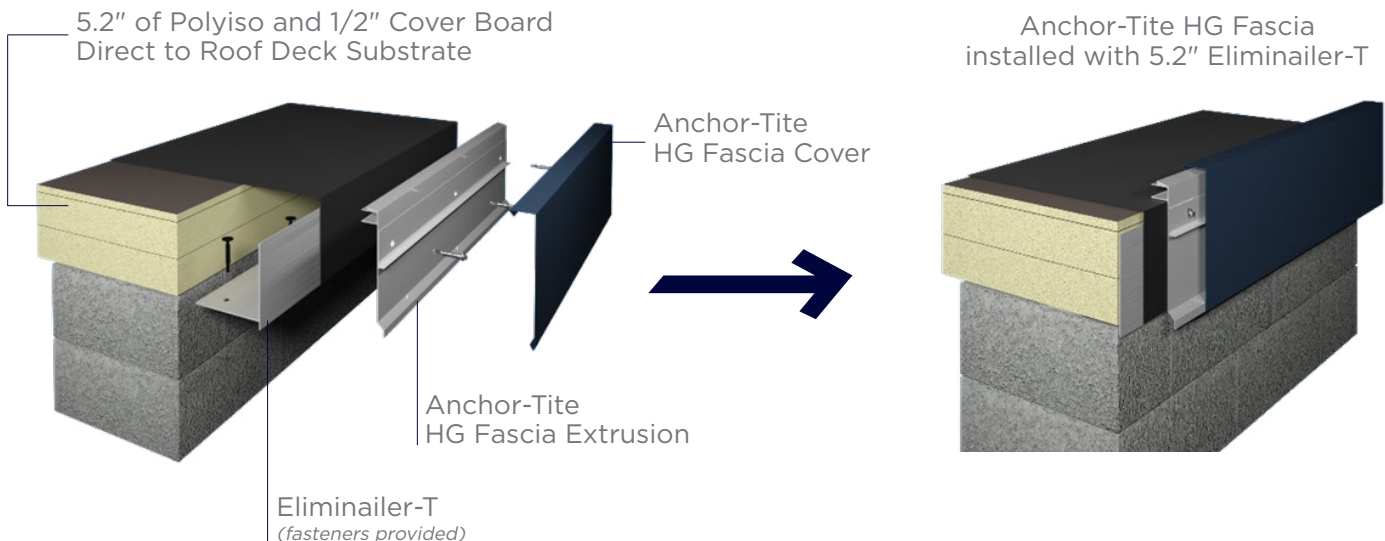
215 MPH Lifetime Wind Warranty

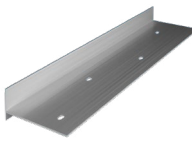

ELIMINAILER-T

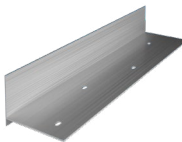
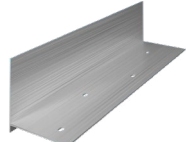
SIZES	 1.5" FACE X 2.5" FLANGE	 1.5" FACE X 5.5" FLANGE	 3" FACE X 2.5" FLANGE	 3" FACE X 5.5" FLANGE	 5.2" FACE x 4" FLANGE 5.2" FACE x 5.5" FLANGE
MATERIAL	Heavy Gauge Extruded Aluminum				
MARKET SEGMENT	Metal Roof Retrofits & Low Slope New Construction and Re-roofs featuring consistent insulation height along the roof perimeter, non-tapered applications				
INSTALLATION FEATURE	Installs onto metal stud walls or existing wood nailers, if secure	Installs directly onto roof deck substrate for pre-cast, masonry, concrete & metal stud walls	Installs onto metal stud walls or existing wood nailers, if secure	Installs directly onto roof deck substrate for pre-cast, masonry, concrete & metal stud walls	Installs directly onto roof deck substrate for pre-cast, masonry, concrete & metal stud walls
INSTALLATION ADVANTAGE	Replaces 1 wood nailer & allows 1.5" of Polyiso & 1/2" cover board or up to 2" of Polyiso		Replaces 2 wood nailers & allows 3" of Polyiso & 1/2" cover board or up to 3.5" of Polyiso		Replaces 3 wood nailers & allows 5.2" of Polyiso & 1/2" cover board or up to 5.7" of Polyiso
ADDED THERMAL BENEFIT	Up to an added R-11.4 to the edge	Up to an added R-11.4 to the edge	Up to an added R-20.5 to the edge	Up to an added R-20.5 to the edge	Up to an added R-32 to the edge
STRUCTURAL BENEFIT	FM Tested: 1-990 ES-1: 1200 PSF	FM Tested: 1-990 ES-1: 1200 PSF	FM Tested: 1-990 ES-1: 1200 PSF	FM Tested: 1-990 ES-1: 1200 PSF	FM Tested: 1-990 ES-1: 1200 PSF
WARRANTY	215 MPH Lifetime Limited Wind Warranty	215 MPH Lifetime Limited Wind Warranty	215 MPH Lifetime Limited Wind Warranty	215 MPH Lifetime Limited Wind Warranty	215 MPH Lifetime Limited Wind Warranty
METAL RETROFIT APPLICATIONS	Available inverted for regular metal retrofit applications or standard configuration for metal retrofits with added insulation, pitched up to 4/12				Inverted & standard configuration, non-pitched only

EDGEBOX RI



SIZES	Min: 3.5" Max: 16" (Width) Min: 1.25" Max: 16" (Height)
MATERIAL	20 Ga. Galvanized Steel Box (Spines required over 6")
MARKET SEGMENT	Low Slope New Construction and Re-roofs With Parapet Wall
INSTALLATION FEATURE	Comes in two pieces and provided fasteners for easy installation. The bottom section is secured directly to the roof deck and the top piece is fastened securely in place.
INSTALLATION ADVANTAGE	Available in any size up to 16-inches square, but is typically made to match 2x wood nailers. For example, a 4.5- tall x 5.5-inch wide size will match three, 2- x 6-in. stacked wood nailers commonly used.
ADDED THERMAL BENEFIT	Provides the same Insulation values of the cover board or spray foam insulation used.
STRUCTURAL BENEFIT	FM Tested*: Up to 1-540 perimeter rating and an FM 1-360 corner rating. ES-1*: Up to 526 PSF (Horizontal) and 911 PSF (Vertical) (*Max 4.5" Height and 5.5" Width)
WARRANTY	215 MPH, Lifetime Limited Wind Warranty



Metal-Era LLC
1600 Airport Road
Waukesha, WI 53188

www.metalera.com
info@metalera.com
800-558-2162